

Signal reliability improvement using selection combining based macro-diversity for off-body communications at 868 MHz

Yoo, SK, Cotton, S, McKernan, A & Scanlon, W

Author post-print (accepted) deposited by Coventry University's Repository

Original citation & hyperlink:

Yoo, SK, Cotton, S, McKernan, A & Scanlon, W 2015, Signal reliability improvement using selection combining based macro-diversity for off-body communications at 868 MHz. in 2015 9th European Conference on Antennas and Propagation (EuCAP). IEEE, pp. 1-5, 9th European Conference on Antennas and Propagation , Lisbon, Portugal, 12/04/15.

Publisher: IEEE

© 2015 IEEE. Personal use of this material is permitted. Permission from IEEE must be obtained for all other uses, in any current or future media, including reprinting/republishing this material for advertising or promotional purposes, creating new collective works, for resale or redistribution to servers or lists, or reuse of any copyrighted component of this work in other works.

Copyright © and Moral Rights are retained by the author(s) and/ or other copyright owners. A copy can be downloaded for personal non-commercial research or study, without prior permission or charge. This item cannot be reproduced or quoted extensively from without first obtaining permission in writing from the copyright holder(s). The content must not be changed in any way or sold commercially in any format or medium without the formal permission of the copyright holders.

This document is the author's post-print version, incorporating any revisions agreed during the peer-review process. Some differences between the published version and this version may remain and you are advised to consult the published version if you wish to cite from it.

Signal Reliability Improvement using Selection Combining Based Macro-Diversity for Off-Body Communications at 868 MHz

Seong Ki Yoo, Simon L. Cotton, Adrian McKernan and William G. Scanlon
Institute of Electronics, Communication & Information Technology
Queen's University Belfast, BT3 9DT, UK
{syoo02, simon.cotton, a.mckernan, w.scanlon}@qub.ac.uk

Abstract—This paper investigates the potential improvement in signal reliability for outdoor short-range off-body communications channels at 868 MHz using the macro-diversity offered by multiple co-located base stations. In this study, ten identical hypothetical base stations were positioned equidistantly around the perimeter of a rectangle of length 6.67 m and width 3.3 m. A body worn node was placed on the central chest region of an adult male. Five scenarios, each considering different user trajectories, were then analyzed to test the efficacy of using macro-diversity when the desired link is subject to shadowing caused by the human body. A number of selection combining based macro-diversity configurations consisting of four and then ten base stations were considered. It was found that using a macro-diversity system consisting of four base stations (or equivalently signal branches), a maximum diversity gain of 22.5 dB could be obtained while implementing a 10-base station setup this figure could be improved to 25.2 dB.

Index Terms—shadowed fading, off-body communications, macro-diversity, diversity gain.

I. INTRODUCTION

In body-centric communications, wireless devices positioned in or on the human body typically communicate with nodes located on the same body or situated in the local surroundings. Over short distances of a few to tens of wavelengths, the signal propagation in body centric communications channels is generally characterized by three factors, which are path loss, small-scale fading (multipath) and body-shadowing. The path loss generally depends on the distance between transmitter and receiver. The multipath, caused by the reflections and scattering from nearby objects and from the human body [1], can cause rapid variability of amplitude of the received signal when the human moves over a distance in the order of a wavelength or more. Body-shadowing is caused when the direct signal path is obscured by the body itself and surrounding people. All of these factors can act to degrade the overall performance of body centric communications systems [2].

A number of diversity techniques are generally employed in wireless communications to help overcome these deleterious effects [3]. These include schemes based on space, time, frequency and polarization diversity. All of these diversity techniques can provide improved signal reliability if the diversity branches are uncorrelated and subject to received signals with comparable mean levels [4]. Space diversity, which is based on multiple, spatially separated, antennas at the

receiver, is the most commonly used compared to other diversity techniques due to its power- and bandwidth-efficiency [5]. It can be categorized into micro- and macro-diversity according to the allocation of the antennas. In micro-diversity, the distance between receive antennas at a single base station is typically in the order of or shorter than the wavelength (λ). Micro-diversity is a well-known method to combat the impact of multipath. On the other hand, in macro-diversity based systems, the separation distance between receive antenna elements is much longer than a wavelength and they will often reside in different spatially separated base stations. Macro-diversity is generally employed to mitigate the effects of shadowing.

There has been much research on diversity techniques for off-body [6-8] communications to improve signal reliability at the receiver. In [6], for enhanced ultra wideband (UWB) indoor off-body communications in the frequency range 2.2-11 GHz, it was found out that higher diversity gains were obtained for non-line-of-sight (NLOS) scenarios compared to line-of-sight (LOS) scenarios due to highly uncorrelated branch signals and low power imbalance. In [7], the influence of pedestrian effects on off-body communications channels in an indoor populated environment at 5.8 GHz, which may induce temporal fading and cause body shadowing, was mitigated using two identical receive antennas separated by $5\lambda/4$. In [8], a hypothetical base station featuring four identical antennas, which were aligned along a straight line with an equal spacing of half-wavelength, was utilized in an indoor environment at 5.8 GHz. It was found that all three combining schemes (selection combining, equal gain combining and maximal ratio combining) achieved a worthwhile signal improvement in the majority of the scenarios for indoor off-body communications.

What is common amongst all of the previously mentioned studies is that they have considered micro-diversity systems positioned either on the human body or at base station. However, the use of micro-diversity may not be sufficient to overcome channel impairments particularly when shadowing due to the human body is the prevalent factor. To mitigate against the deleterious effects of human body shadowing in off-body communications at 868 MHz, six hypothetical receiver branches were distributed across the front and back torso of the human body [9]. By comparing the diversity gain between two-branch and six-branch systems, the benefit of

This work was supported by the U.K. Royal Academy of Engineering and the Engineering and Physical Research Council (EPSRC) under Grant Reference EP/H044191/1 and EP/L026074/1, and also by the Leverhulme Trust, UK.

having more than two branches in off-body systems was demonstrated. Nonetheless, there are many drawbacks to building diversity systems designed to be worn on the human body. Especially when compared to integrating the technology into a local base station or using combining opportunities offered by multiple base stations. These include potential obstruction to the user, the additional weight of body worn receiver branches, associated circuitry and enclosures and also the extra drain on battery life.

To the best of our knowledge, the issue of macro-diversity used to overcome shadowing for off-body communications channels has not yet been published in the open literature. Therefore, in this paper, we investigate the potential improvement that may be obtained using the combined signal forwarded from several multiple spatially distributed base stations operating at 868 MHz.

II. MEASUREMENT SET-UP, EXPERIMENTS AND DATA ANALYSIS

A. Measurement Set-Up and Experiments

The body worn node used in this study consisted of a CC1110F32 RF transceiver, manufactured by Texas Instruments (TI) which was configured to transmit a 9 byte data packet at 0 dBm every 20 ms using minimum-shift keying and a data rate of 500 kbaud. The unit operated at 868 MHz using a printed meander-line monopole antenna. The node was mounted parallel to the central chest region of an adult male of height 1.70 m and mass 75 kg. The test subject wore a sports T-shirt (86% polyester / 14% elastane) with a special holding pocket purposely sown on to the garment at the central chest region.

The hypothetical base station array consisted of 10 identical equally spaced base stations which were positioned in a rectangular configuration with a length of 6.67 m and a width of 3.3 m as shown in Figs. 1 and 2. The purposely developed base station units also consisted of a CC1110F32 RF transceiver configured to record the received signal strength of each received packet. The antenna used by base station nodes was +6.0 dBi omnidirectional monopole antenna which was positioned at a height of 1 m from ground level using a non-conductive support.

All of the experiments conducted in this study were carried out in an outdoor playing field at the Ormeau Park within the city of Belfast in the United Kingdom as shown in Fig 1. Five individual measurement scenarios all based around a walking test subject were considered as shown in Fig 2. These scenarios can be broadly categorized into the movement which the walk path followed. These included a rectangular shape (scenarios 1 and 2), a diagonal-line walk path (scenario 3) and a meandering walk path (scenarios 4 and 5).

B. Data Analysis

In this paper, a selection combining (SC) scheme was used with the hypothetical macro-diversity system to combine the signal waveform forwarded from each of the chosen base stations in post processing. This straightforward combining

technique allowed the macro-diversity system to switch to the base station with the highest signal level. Thus for the macro-diversity systems considered here, which consisted of M base stations, the SC output level R was

$$R_{SC} = \max(r_1, r_2, \dots, r_M) \quad (1)$$

where r_M is the signal level observed in the M^{th} base station.

For a diversity scheme to be effective, each base station should receive statistically independent versions of the transmitted signal reducing the likelihood that all base stations are experiencing correlated fading. Two signals are said to be suitably de-correlated if their cross-correlation coefficient is less than 0.7 [10]. The performance of the macro-diversity system was evaluated in terms of its macro-diversity gain, which is defined as the difference in the received signal level of the target base station (which for this study was base station 5, Fig. 2) and that of the selection combined signal for a given probability of signal reliability. All diversity gain calculations in this paper were made at a signal reliability of 90%. Please note that we consider three different potential groupings of base stations. These were: *group 1* – all ten base stations; *group 2* – a four base station configuration consisting of base stations 1, 4, 6 and 9; *group 3* – another four base station configuration consisting of base stations 3, 5, 8 and 10.



Fig. 1 Experimental environment: Outdoor playing field at the Ormeau Park.

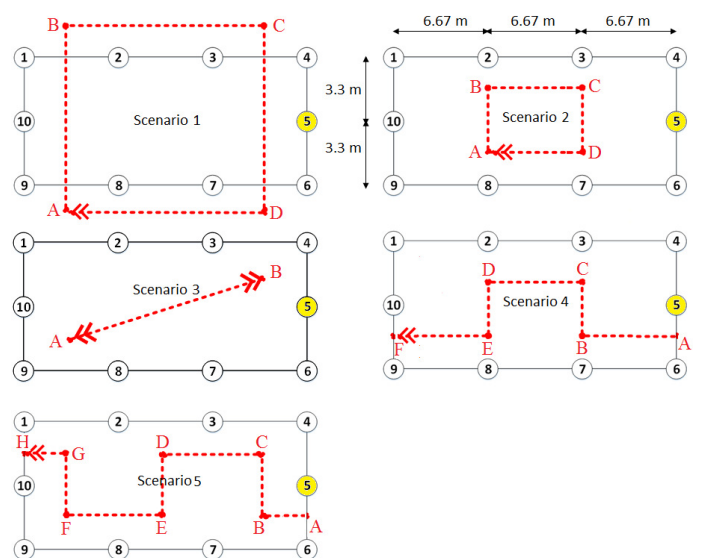

Fig. 2 Five individual measurement scenarios considered in this study. It should be noted that the red dotted line represents the user's walk path and the target base station was yellow-highlighted.

III. RESULTS

Fig. 3 shows the cumulative distribution function (CDF) for all the cross-correlation coefficients calculated for all scenarios. As shown in Fig. 3, the majority of the estimated cross-correlation coefficients were between -0.7 and 0.7. This suggests that a macro-diversity receiver equipped with multiple base stations should provide sufficient dissemination of the transmitted signal to supply worthwhile diversity.

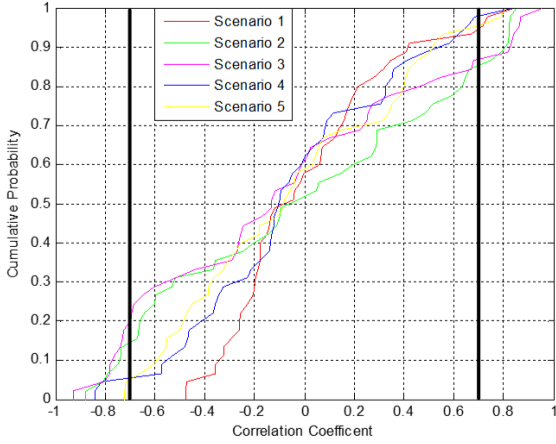

Fig. 3 CDFs of cross-correlation coefficients calculated for all scenarios

A. Scenarios 1 and 2 – Movement along Rectangular Paths

In scenarios 1 and 2, the test subject walked along rectangular paths of differing size (Fig. 2). The state of the direct signal path between the body worn node and each base station alternated between LOS and NLOS while the test subject was walking. For example, Fig. 4 shows the raw received signal power time series for base stations 1, 4, 6 and 9 (*group 2*) and the selection combined received signal power time series for scenario 1. As we can see, there were several changes between LOS and NLOS at each base station highlighting the variable shadowing conditions experienced in this scenario. Accordingly, the macro-diversity system switched to the base station with the highest signal level. For example, when test subject began to walk along path AB, base stations 1 and 9 were closest and in LOS. However at around 4 seconds, the test subject's body begins to obscure the direct signal path to base station 9. This effect can be observed in Fig. 3 where the selection combined signal can be seen to track the output of base station 9 for the first 4 seconds at which point the combiner switches to the output of base station 1. When the test subject turned to walk along path BC, both of these base stations became shadowed and the macro-diversity system switched between base stations 4 and 6. Similarly, the macro-diversity system alternated between base stations 6 and 9 along path CD and then switched to base station 1 along path DA. That is, the different base stations with the highest (non-shadowed) received signal power were selected (base stations $9 \rightarrow 1 \rightarrow 6 \rightarrow 4 \rightarrow 6 \rightarrow 9 \rightarrow 6 \rightarrow 9$).

Fig. 5 shows the raw received signal power time series for base stations 1, 4, 6 and 9 and the diversity combined received

signal power time series for scenario 2. Here the test subject followed the small rectangular walk path, the number of changes between LOS and NLOS at each base station was less than that for scenario 1. This led the macro-diversity system for scenario 2 to switch between the base stations less frequently compared to that for scenario 1 (base stations $1 \rightarrow 4 \rightarrow 6 \rightarrow 9$). It can be seen quite clearly that for this scenario, using a macro-diversity system consisting of base stations 1, 4, 6 and 9, a significant improvement in signal reliability could be achieved in which all signal drops below the -71 dBm level are eradicated.

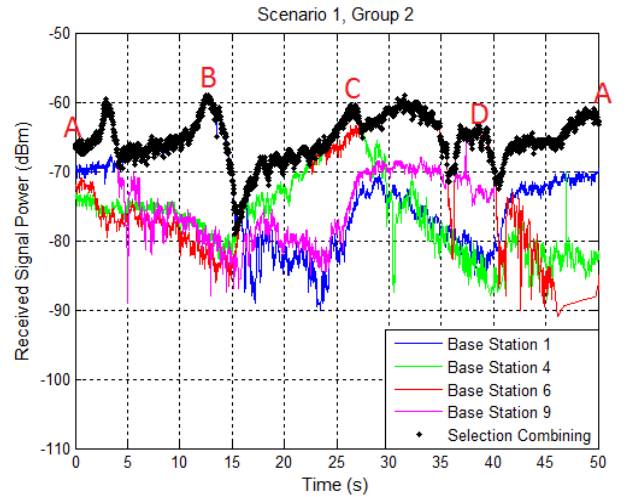

Fig. 4 Received signal power at base stations 1, 4, 6 and 9 alongside the diversity combined received signal power for scenario 1.

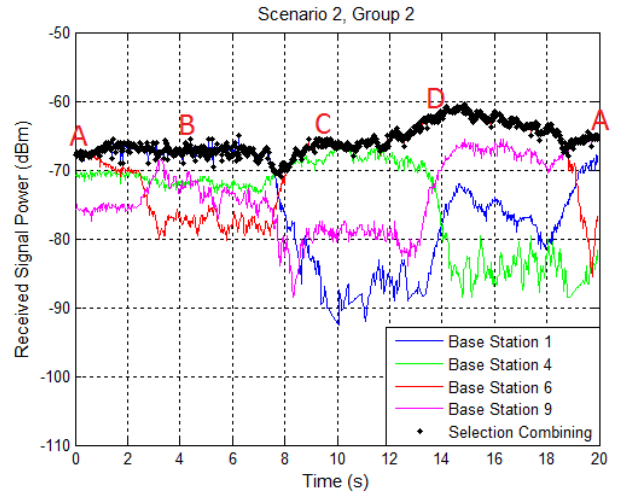

Fig. 5 Received signal power at base stations 1, 4, 6 and 9 alongside the diversity combined received signal power for scenario 2.

Table I shows the estimated diversity gain values for each of the three combining macro-diversity system groupings at 90% signal reliability for scenarios 1 and 2. As mentioned above, the link between the body worn node and base station 5 was considered as the target (i.e. the reference link). As expected, *group 1* which featured 10 base stations provided the highest overall diversity gains. The diversity gain in scenario 1

where test subject followed the large rectangular walk path was higher compared to that for scenario 2. This was most likely due to fact that in scenario 1 the test subject moved across the border between base stations more frequently compared to scenario 2, meaning that the system benefited more from the macro-diversity because of the increased number of shadowing events.

TABLE I. DIVERSITY GAIN FOR ALL MEASUREMENT SCENARIOS

Scenario	Diversity Gain (dB)		
	Group 1	Group 2	Group 3
1	17.0	14.6	14.0
2	9.6	7.3	8.2
3	18.0	15.5	16.5
4	25.2	21.5	22.5
5	23.6	19.9	20.9

B. Scenario 3 – Movement along Diagonal Path

In scenario 3, the test subject started at point A, moved towards and then away from point B, following a diagonal-line between base stations 4 and 9. For *group 3*, at the beginning of this scenario, the direct signal path to base stations 3 and 5 were largely in LOS and thus the macro-diversity system selected either base station 3 or 5 (Fig. 6). However, when the test subject walked away from point B, these base stations became shadowed and the system switched between base stations 8 and 10.

The benefits of using a macro-diversity system for this type of scenario are again demonstrated in Fig. 6 where the all signal drops below -72 dBm are removed. Fig. 7 shows the CDF for scenario 3 with the output of the three macro-diversity system groupings alongside the CDF of the link with target base station. Here, two other groupings of base stations were also considered for the further comparison. These were: *group 4* – a two base station configuration consisting of base stations 4 and 9; *group 5* – another two base stations configuration consisting of base stations 5 and 10. It can be seen that using the macro-diversity configurations provided diversity gains of 18.0, 15.5, 16.5, 11.5 and 12.11 dB for the *group 1*, *group 2*, *group 3*, *group 4* and *group 5* respectively.

C. Scenarios 4 and 5 – Movement along Meandering Path

In scenarios 4 and 5, the test subject walked along different meandering trajectories. As shown in Fig. 2, the difference between scenarios 4 and 5 is the point where the test subject changed walking direction. Figures 8 and 9 show the raw received signal power time series for base stations 3, 5, 8 and 10 (*group 3*) and the diversity combined received signal power time series for scenarios 4 and 5, respectively. For scenario 4, when the test subject began to walk towards point B, the macro-diversity system selected base station 5 due to the short distance between this base station and the body worn node. However, at around 1.6 seconds, base station 5 became shadowed by the test subject's body and the macro-diversity system switched to base stations 3 and 8. Similarly, the chosen

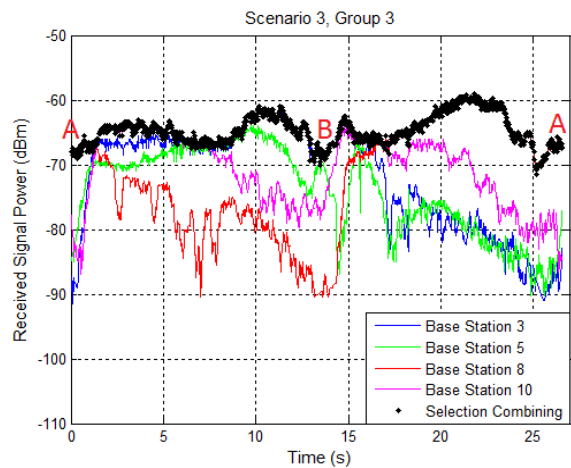

Fig. 6 Received signal power at base stations 3, 5, 8 and 10 alongside the diversity combined received signal power for scenario 3

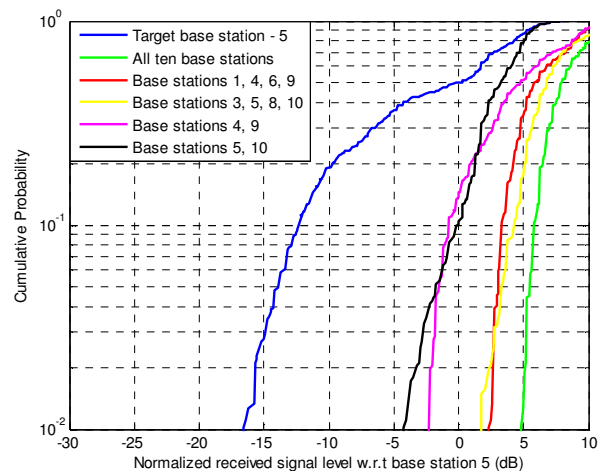

Fig. 7 Empirical CDFs for base station 5 (target base station) and the output of the selection combiner using the five different macro-diversity system groupings for scenario 3.

base station changed as the test subject walked on other paths, namely base stations $5 \rightarrow 3 \rightarrow 8 \rightarrow 3 \rightarrow 8 \rightarrow 10 \rightarrow 8 \rightarrow 10$ (Fig. 8). In scenario 5, the test subject changed walking direction more often than during scenario 4. Therefore, as shown in Fig. 9, there were more variations in the received signal at each base station causing the system to switch between base stations $5 \rightarrow 3 \rightarrow 5 \rightarrow 3 \rightarrow 8 \rightarrow 10 \rightarrow 8 \rightarrow 10$ as the test subject walked along meandering walking path AH.

Table I also shows the diversity gain statistics for each of the three macro-diversity system groupings at 90% signal reliability for scenarios 4 and 5. Again, *group 1* which featured 10 base stations achieved the highest overall diversity gains. Interestingly, the diversity gain obtained in scenario 5 was smaller compared to that for scenario 4 although the test subject in scenario 5 changed walking direction more often compared to scenario 4. This was most likely due to fact that the test subject did not move across the border between base stations on path FG and GH. Moreover, for scenario 5, the received signal level at base station 5 (target base station) was slightly greater than that for scenario 4 (0.8 dB at 90% signal reliability, Fig. 10). This is because the state of signal path

between the body worn node and base station 5 for scenario 5 was in LOS for a greater length of time than for scenario 4.

IV. CONCLUSION

The potential improvement in signal reliability for outdoor short-range off-body communications at 868 MHz using macro-diversity provided by multiple base stations has been investigated. A simple SC scheme was utilized with three macro-diversity system groupings. It was found that a substantial improvement in signal reliability could be achieved for all of the scenarios considered in this study. Furthermore, it is also worth noting that opting for macro-diversity configurations consisting of more than four base stations may not yield significantly superior results. The largest difference in diversity gain between the four and ten base station groupings analyzed here was found to be just 3.8 dB. This figure may not be enough to justify the complexity and overheads associated with the operation of a ten base station macro-diversity configuration. Nonetheless, these improvements will undoubtedly help to mitigate the deleterious effects of human body shadowing in off-body communications systems operating in outdoor environments.

From a systems perspective, a simple SC scheme is unlikely to be chosen. This is because it is required to estimate the signal to noise ratio (SNR) of all paths simultaneously. In practice, SC is often implemented as switching diversity by comparing the SNR of the paths with a fixed threshold. This can reduce the complexity of the receiver because it switches from one branch to another only when needed [11]. Therefore for the future work, it is worth investigating the performance of switching diversity with switch-and-stay or switch-and-examine schemes.

REFERENCES

- [1] A. A. Serra, P. Nepa, G. Manara, and P. S. Hall, "Diversity measurements for on-body communication systems," *IEEE Antennas and Wireless Propagation Letters*, vol. 6, pp. 361-363, Oct. 2007.
- [2] S. L. Cotton and W. G. Scanlon, "Characterization and modeling of the indoor radio channel at 868 MHz for a mobile bodyworn wireless personal area network," *IEEE Antennas and Wireless Propagation Letters*, vol. 6, pp. 51-55, March 2007.
- [3] G. L. Stüber, *Principles of mobile communications*, Springer, 3rd edition.
- [4] A. Molisch, *Wireless Communications*, Piscataway, Wiley, 2005.
- [5] J. Boutros and E. Viterbo, "Signal space diversity: a power and bandwidth-efficient diversity technique for Rayleigh fading channel," *IEEE Transactions on Information Theory*, vol. 44, no. 4, pp. 1453-1467, July 1998.
- [6] Q. H. Abbasi, M. M. Khan, A. Alomainy and Y. Hao, "Diversity antenna techniques for enhanced ultra wideband body-centric communications," *IEEE International Symposium on Antennas and Propagation (APSURSI)*, pp. 1323-1326, Washington, USA, July 2011.
- [7] A. J. Ali, S. L. Cotton and W. G. Scanlon, "Spatial diversity for off-body communications in an indoor populated environment at 5.8 GHz," *Loughborough Antennas and Propagation Conference (LAPC)*, pp. 641-644, Loughborough, UK, Nov. 2009.
- [8] S. K Yoo and S. L. Cotton, "Improving signal reliability for indoor off-body communications using spatial diversity at the base station", *8th European Conference on Antennas and Propagation (EuCAP)*, pp. 857-861, Hague, Netherlands, April 2014.

- [9] S. L. Cotton and W. G. Scanlon, "Measurements, modeling and simulation of the off-body radio channel for the implementation of bodyworn antenna diversity at 868 MHz," *IEEE Transactions on Antennas and Propagation*, vol. 57, no. 12, pp. 3951-3961, Dec. 2009.
- [10] W. C. Jakes, *Microwave mobile communications*. New York: Wiley, 1974.
- [11] M. K. Simon and M. S. Alouini, *Digital Communication over Fading Channels*, Wiley, 2nd edition.

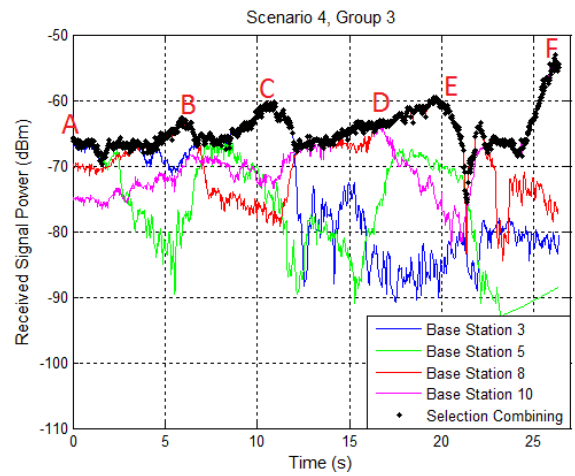

Fig. 8 Received signal power at base stations 3, 5, 8 and 10 alongside the diversity combined received signal power for scenario 4.

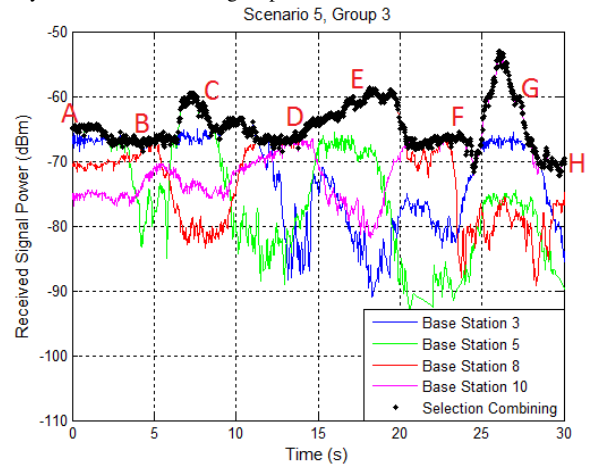

Fig. 9 Received signal power at base stations 3, 5, 8 and 10 alongside the diversity combined received signal power for scenario 5.

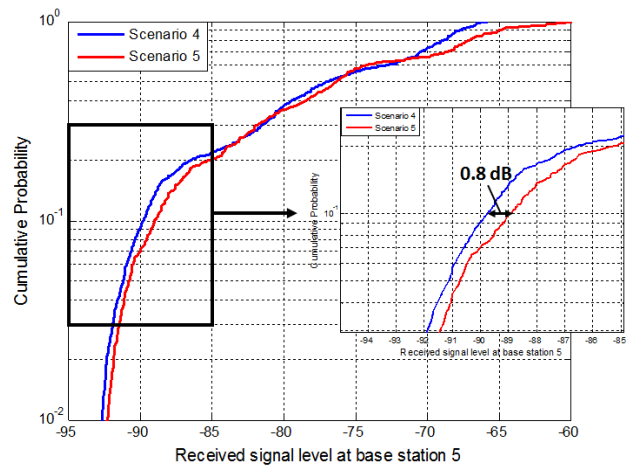

Fig. 10 CDFs for base stations 5 (target base station) during scenarios 4 and 5.